

# **4/8/16/32-Ch Network Video Recorder**

## **NVR Series**

### **Quick Installation Guide**

# Table of Contents

Chapter 1. Introduction .....	3
1.1 Before Installation .....	3
Chapter 2. Physical Description and Installation.....	4
2.1 4-Ch Network Video Recorder.....	4
2.1.1 NVR-401 Package Content.....	4
2.1.2 NVR-401 Physical Details .....	4
2.1.3 NVR-401 Installation.....	5
2.1.4 NVR-420 Package Content.....	7
2.1.5 NVR-420 Physical Details .....	7
2.1.6 NVR-420 HDD Installation .....	8
2.2 8/16-Ch Network Video Recorder.....	13
2.2.1 NVR-810 / NVR-1610 Package Content.....	13
2.2.2 NVR-810 / NVR-1610 Physical Details .....	13
2.2.3 NVR-810 / NVR-1610 Installation.....	15
2.3 32-Ch Network Video Recorder.....	17
2.3.1 NVR-3210 Package Content.....	17
2.3.2 NVR-3210 Physical Details.....	17
2.3.3 NVR-3210 Installation.....	18
2.3.4 NVR-3250 Package Content.....	19
2.3.5 NVR-3250 Physical Details.....	20
2.3.6 NVR-3250 HDD Installation .....	21
2.4 Web Management.....	24

---

## ***Chapter 1. Introduction***

Thank you for purchasing the PLANET 4/8/16/32-Ch Network Video Recorder. The Network Video Recorder is designed for use within a surveillance system, and performs recordings and playbacks pictures from network cameras in the system. It is a recording device using a hard disk drive to record camera pictures instead of using video tapes so that pictures recorded by repeated overwriting will not experience deterioration of the recorded picture quality. Up to 4 (for NVR-401 and NVR-420), 8 (for NVR-810), 16 (for NVR-1610) and 32 (for NVR-3210 and NVR-3250) cameras can be connected via a network and it is possible to record their camera pictures. It is possible to perform the settings or operate the NVR using a web browser installed on a PC connected to a network, or remote controller. Recorded video can be played back from remote site by a PC. Up to 4 PCs (web browsers) can access this unit concurrently and it is possible to perform the settings and operate this unit. The NVR is compatible with most major brand cameras and its ability to automatically search and find the available cameras on the network can greatly reduce the user effort when expanding the system.

### **1.1 Before Installation**

Before installation, please be sure to read this quick installation guide and user's manual (CD) carefully to complete machine installation. This guide shows how to quick set up the NVR, unless model name specified terms "Network Video Recorder" will be used for these models.

## Chapter 2. Physical Description and Installation

### 2.1 4-Ch Network Video Recorder

#### 2.1.1 NVR-401 Package Content

1 x NVR	1 x Power Cord	1 x Power Adapter
1 x RJ-45 Cable	1 x CD-ROM	8 x HDD Screw
1 x Quick Installation Guide		

#### 2.1.2 NVR-401 Physical Details

##### Front Panel

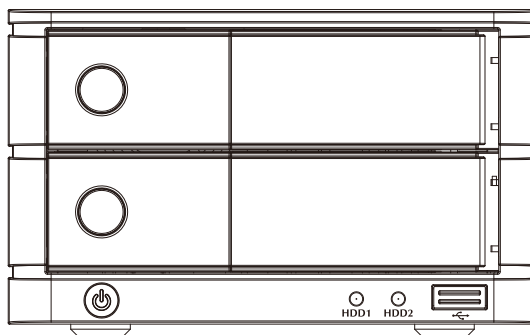

LEDs	Color	Description
Power	Blue	On: Power on. Off: Power off.
HDD	Green	Blinking: HDD is accessing. Off: HDD is no action.

Button	Description
Power	Press to start or shut down.

Connector	Description
USB	Connect your USB flash disk for firmware upgrade.

## Rear Panel

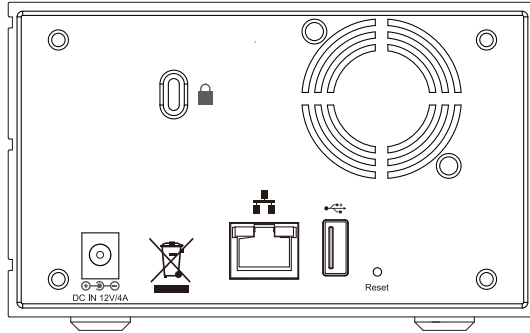

Connector	Description
DC Connector	Connect the bundled power adapter.
Ethernet	Supports 10/100/1000Base-T interface.
USB	Connect your USB flash disk for firmware upgrade.

Button	Description
Reset	Press to reset NVR to factory default.

### 2.1.3 NVR-401 Installation

1. Push the silver button to release the HDD tray.



2. Pull out the HDD tray.



3. Place the HDD on the tray and secure the HDD with the screws at the bottom (as illustrate).



4. Push the tray back in the unit and press down the black bar to secure the tray.



## 2.1.4 NVR-420 Package Content

1 x NVR	1 x Power Cord	1 x Power Adapter
1 x RJ-45 Cable	1 x CD-ROM	8 x HDD Screw
1 x Remote control		1 x Quick Installation Guide

## 2.1.5 NVR-420 Physical Details

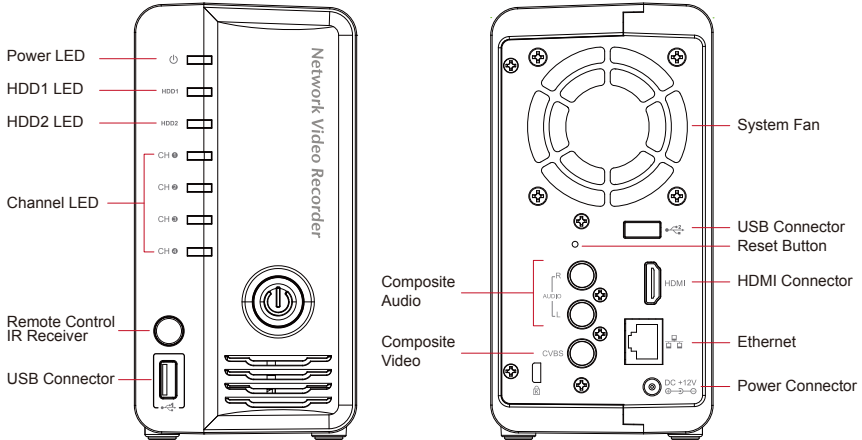

LEDs	Color	Description
Power	Green	When NVR-420 is fully started
	Red	When NVR-420 is off, but power cord remains plugged in
	Amber	Blinking during system initialization, reboot, and firmware upgrade
	Off	When NVR-420 is off and the power cord is not plugged in
HDD1/2	Green	Disk is online
	Red	Disk error
	Amber	Solid amber When NVR-420 is recording Blinking amber when the disk is recycling
	Off	No disk or disk is offline
Channel 1~4	Green	Solid green when NVR-420 is online Blinking during event triggered
	Off	Disconnect or no camera is configured

Connector	Description
USB	Connect your USB flash disk for firmware upgrade and backup
Reset	Press and hold reset button for 30 seconds to factory default
HDMI	HDMI output
Ethernet	10/100Mbps network

### 2.1.6 NVR-420 HDD Installation

1. Locate the screws highlighted above on the back of the NVR.



2. Use a Philips screw driver to release the screws.



3. Slide opens the case as shown above.

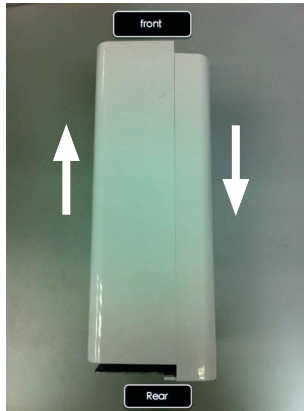

4. One side of the housing can be detached as shown above.



5. Install the bottom HDD by slide it in to the tray diagonally to avoid the tray separator.



6. Once the HDD is placed into the tray, you should see a gap between the HDD and the SATA connector.



7. Attach the HDD to the SATA connector by sliding it towards the connector.



8. Make sure the screw holes on the HDD are aligned with the ones on the tray.



9. Secure the HDD with the screws provided in the accessory box with a Philips screw driver. There are four for each HDD; two for each side of the tray.

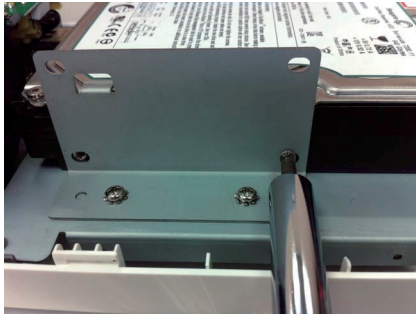

10. Install the top HDD by attaching it to the corresponding SATA cable first.

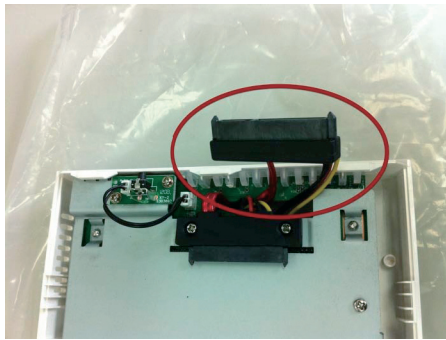

11. Make sure the HDD is securely attached.



- Place the HDD to the tray and make sure the screw holes on the HDD are aligned with the ones on the tray.

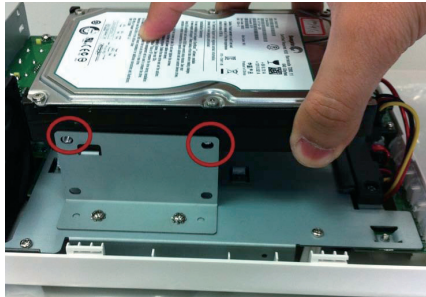

- Secure the HDD with the screws provided in the accessory box with a Philips screw driver. There are four for each HDD; two for each side of the tray.



- Slide the side housing back to the unit.

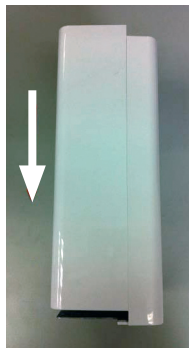

15. Secure the housing with the screws highlighted above.



## 2.2 8/16-Ch Network Video Recorder

### 2.2.1 NVR-810 / NVR-1610 Package Content

1 x NVR	1 x Power Cord	1 x RJ-45 Cable
1 x CD-ROM	2 x HDD Screw	1 x Quick Installation Guide

### 2.2.2 NVR-810 / NVR-1610 Physical Details

#### Front Panel

NVR-1610

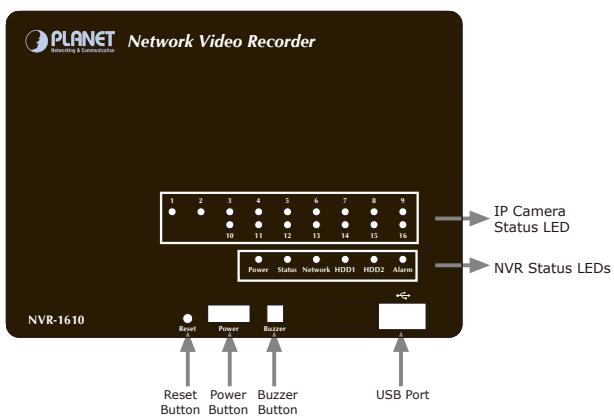

NVR-810

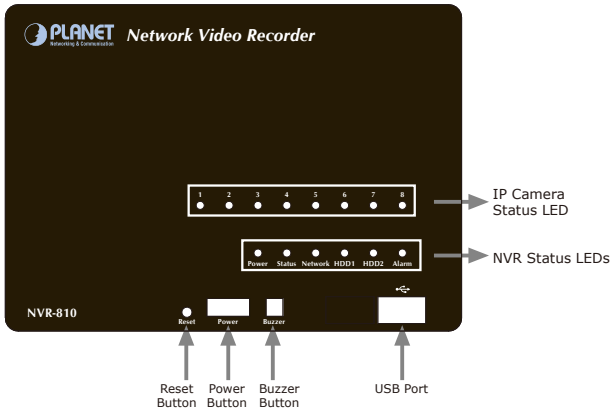

LEDs	Color	Description
Power	Green	Normal operation
	Red	System off (power adapter remains plugged in)
	Amber	Blinking amber indicating device is initializing
HDD1/2	Green	Solid green when the hard disk is mounted and being accessed
	Red	Solid red for disk fail
	Amber	Solid amber when disk is recording Blinking when recycling
Network	Amber	Solid amber for activity on a 1G bps network
	Green	Solid green for activity on a 10/100 Mbps network
Status	Amber	Blinking during firmware upgrade
	Green	Shows solid green for normal operation Blinking green when firmware upgrade is done
	Red	Flashes red for failed firmware upgrade
Alarm	Red	Blinking when an alarm occurs
	None	When alarm is reset

Camera	Green	Solid green, live connected with no event or recording activity
	Amber	Blinking amber, manual or event recording is being performed
	Amber	Solid amber, schedule or continuous recording is being performed
	Red	Recording is set but no video from camera

## 2.2.3 NVR-810 / NVR-1610 Installation

### 2.2.3.1 Installing the Hard Disk Drive

1. Removing the screws on the side.



2. Push the top housing forward, then lift it up.

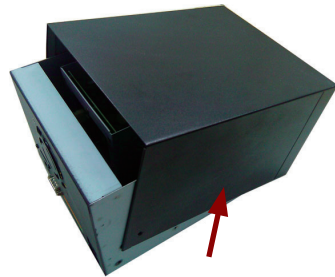

3. Removing the screws on the HDD Tray left and right side.

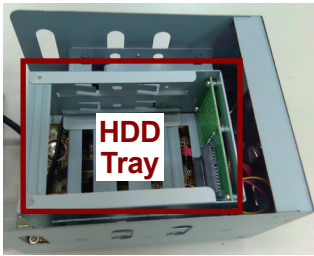

4. Insert the HDD to HDD tray. Please push the HDD until the SATA connect is connected properly, and lock the HDD Screw on left and right side.

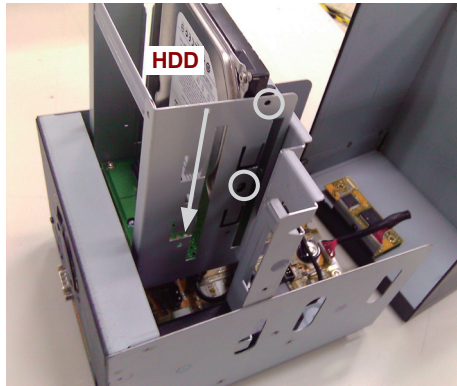

5. If there is a second HDD, please repeat the step 4 to install it.

6. Place the top housing back and secure it with the bottom housing.



7. Connect the bundle power adapter to the power connector in rear panel.
8. Press power button to power on your NVR.

## 2.3 32-Ch Network Video Recorder

### 2.3.1 NVR-3210 Package Content

1 x NVR	1 x Power Cord	1 x RJ-45 Cable
1 x CD-ROM	12 x HDD Screw	1 x Quick Installation Guide
4 x HDD Tray Key		

### 2.3.2 NVR-3210 Physical Details

#### Front Panel

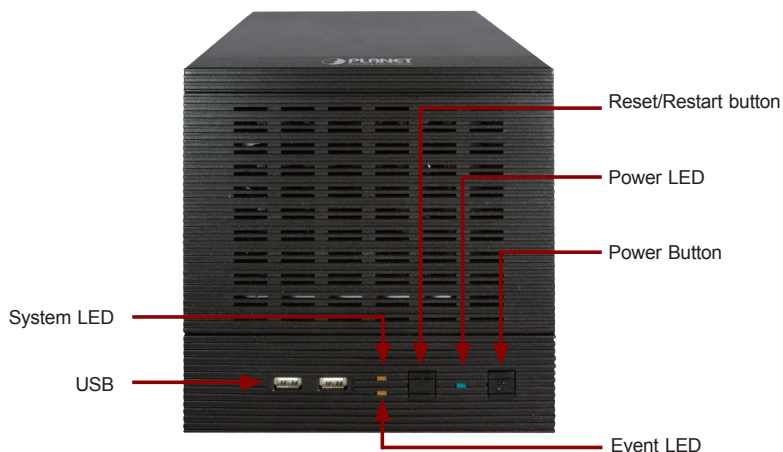

LEDs	Color	Description
System	Amber	Firmware upgrade: blinking System failure (AP fail): off System normal: solid
Event	Amber	Event recording: solid No event: off
Power	Blue	Power on/Restart/Reset to default/OS fail: stays solid

## 2.3.3 NVR-3210 Installation

### 2.3.3.1 Installing the Hard Disk Drive

1. Release the HDD tray by pulling the lock to the right.

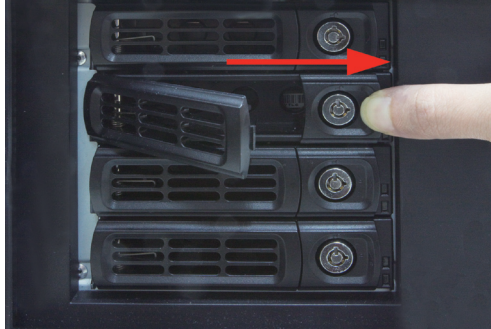

2. Pull the HDD tray out of the case.

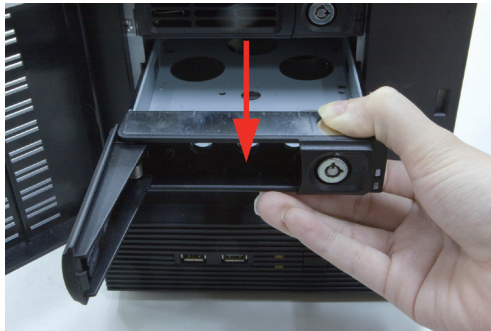

3. Place the HDD in the tray and the bottom of the tray.

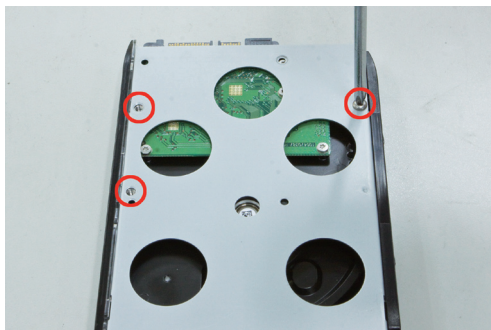

4. Put the HDD tray back to the case.



5. Push the tray door back to the case to secure it.



### 2.3.4 NVR-3250 Package Content

1 x NVR	1 x Power Cord	1 x RJ-45 Cable
1 x CD-ROM	16 x HDD Screw	2 x Angle bar
4 x Angle Screw	4 x Handle Screw	2 x Handle kit
1 x Quick Installation Guide		

## 2.3.5 NVR-3250 Physical Details

### Front Panel

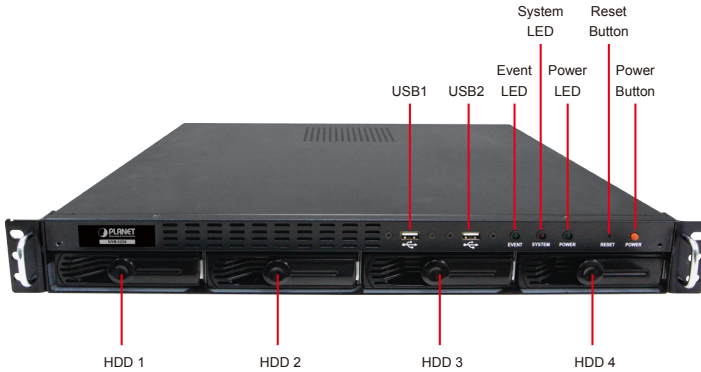

LEDs	Color	Description
Power	Blue	During power on / restart / reset to default / OS fail: Stays solid
System	Amber	During firmware upgrade: Blinking System failure (AP fail): Off System Normal: Solid
Event	Amber	During event recording: Solid No event: Off

### Rear Panel

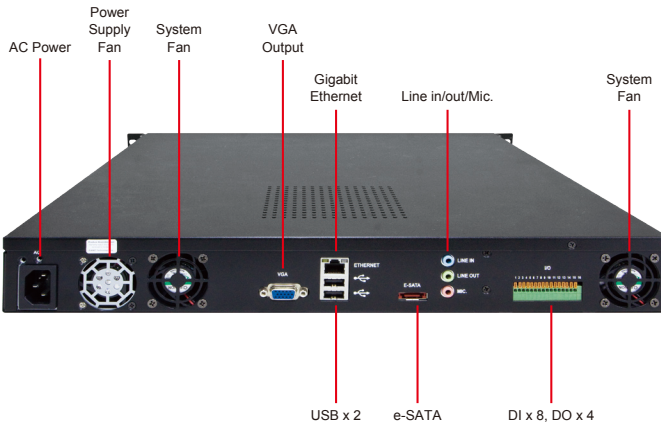

Connector	Description
VGA	VGA output
Ethernet	10/100/1000Mbps network
USB	Connect your USB flash disk for firmware upgrade and backup
E-SATA	External E-SATA HDD
Audio	Line in/Line out/Mic
I/O	DI x 8 / DO x 4

### 2.3.6 NVR-3250 HDD Installation

1. Start by removing the front plate.



2. To remove the front plate, turn the tool-less screws on both sides counter-clockwise to loose it from the unit. Please note the screws will still be attached to the front plate even after the screws are completely loosened from the unit.



3. Simply pull to remove the front plate once the screws are loosened from the unit.



4. Remove the HDD tray by pulling the latch.



5. Push the tray door back to the case to secure it.



6. Once the tray is removed from the unit, notice there are four holes, which are used to secure the HDD.

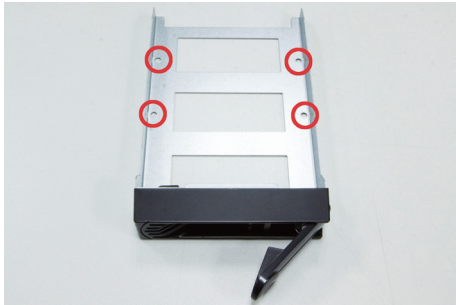

7. Once the HDD is placed in the tray, flip it over and secure the HDD with the screws.

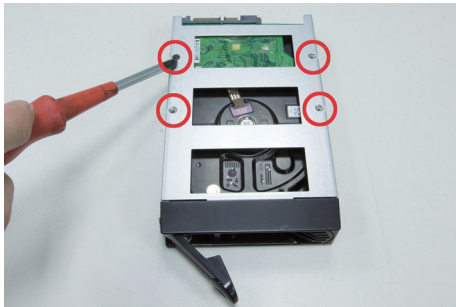

8. Push the tray back in to the unit and push it all the way in.



9. Secure the tray by pushing in the latch, which locks the tray with the unit.



## 2.4 Web Management

### Install "Device Search" utility from the CD

1. Please go to Start => Programs => NVR => Search NVR to run the search tool. Then you will see the utility start search the network.

#### Network Communication

2. The NVR should be located and its IP address should be displayed: Double-click on it and the program should automatically access the NVR's web administration page from your default browser.

State	IP Address	Http Port	Brand	Modal	MAC Address
	192.168.0.20	80	PLANET	NVR-401	00-30-4f-c0-01-4b

### 3. Login the Homepage

The Web management allows you to access and manage the Network Video Recorder easily. Launch the Web browser and then enter the IP address. The default IP address is **192.168.0.20**. And, fill the User Name and Password to login the Web management. The default User Name / Password is **admin / admin**.

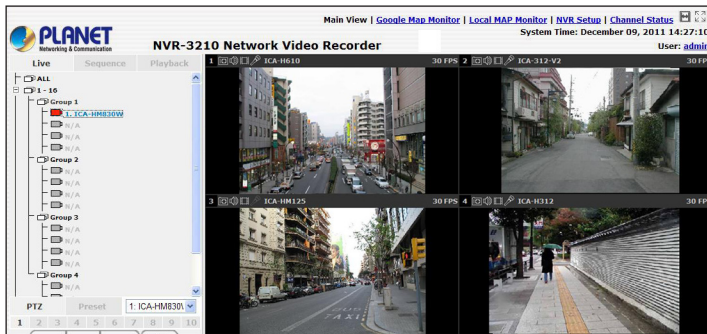
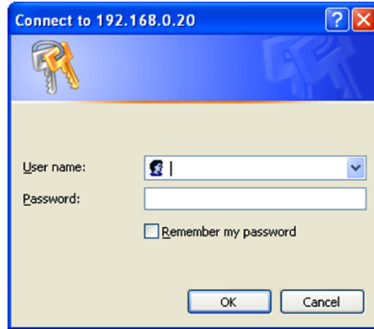

Further configurations and information can be found in the user's manual CD. Please check the user's manual for more understanding.

This page is intentionally left blank

This page is intentionally left blank

This page is intentionally left blank